

Product Feature

1. Package Type: SIP8
2. Operating Temperature Range: -40°C - +105°C
3. Isolation Voltage: 1500VDC
4. 2:1 Wide Input Voltage Range
5. High efficiency up to 83%
6. With the output overcurrent, output short circuit protection mechanism
7. Fields of application: electric power, industrial control, communication, Internet of Things, automobile, rail transit, etc

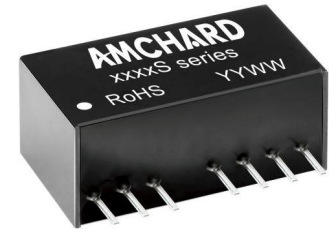

3 years Warranty

Selection Guide

Part No.	Input Voltage (VDC)	Output			Full Load Efficiency% (Min./Typ.)	Capacitive Load Max. (μF)	
	Nominal (Range)	Voltage (VDC)	Current Max.(mA)	Current Min.(mA)			
BTB0503S-3WR2	5 (4.5-9)	3.3	758	38	67/69	1800	
BTB0505S-3WR2		5	600	30	72/74	2200	
BTB0509S-3WR2		9	333	20	74/76	1000	
BTB0512S-3WR2		12	250	13	76/78	680	
BTB0515S-3WR2		15	200	10	73/75	470	
BTB0524S-3WR2		24	125	6	75/77	330	
BTA0505S-3WR2		±5	±300	±15	73/75	1000	
BTA0509S-3WR2		±9	±167	±10	74/76	680	
BTA0512S-3WR2		±12	±125	±6	76/78	470	
BTA0515S-3WR2		±15	±100	±5	76/78	330	
BTA0524S-3WR2		±24	±63	±3	75/77	220	
BTB1203S-3WR2		12 (9-18)	3.3	758	38	74/76	2700
BTB1205S-3WR2	5		600	30	75/77	2200	
BTB1209S-3WR2	9		333	17	77/79	1000	
BTB1212S-3WR2	12		250	13	81/83	680	
BTB1215S-3WR2	15		200	10	82/84	471	
BTB1224S-3WR2	24		125	6	80/82	330	
BTA1205S-3WR2	±5		±300	±15	77/79	1000	
BTA1212S-3WR2	±9		±167	±8	77/79	680	
BTA1209S-3WR2	±12		±125	±6	78/80	470	
BTA1215S-3WR2	±15		±100	±5	79/80	330	
BTB2403S-3WR2	24 (18-36)		3.3	758	38	73/75	2700
BTB2405S-3WR2			5	600	30	80/82	2200
BTB2412S-3WR2		12	250	13	82/84	680	
BTB2409S-3WR2		9	333	17	81/83	1000	
BTB2415S-3WR2		15	200	10	82/84	470	
BTB2424S-3WR2		24	125	6	82/84	330	
BTA2405S-3WR2		±5	±300	±15	78/80	1000	
BTA2409S-3WR2		±9	±167	±8	79/81	680	
BTA2412S-3WR2		±12	±125	±6	81/83	470	
BTA2415S-3WR2		±15	±100	±5	81/83	330	
BTB4803S-3WR2		48 (36-75)	3.3	758	38	74/76	2700
BTB4805S-3WR2			5	600	30	75/77	2200
BTB4812S-3WR2	12		250	13	79/81	680	

BTB4815S-3WR2	15	200	10	83/85	470
BTB4824S-3WR2	24	125	6	81/83	330
BTA4805S-3WR2	±5	±300	±15	78/80	1000
BTA4812S-3WR2	±12	±125	±6	81/83	470
BTA4815S-3WR2	±15	±100	±5	81/83	330

Input Specifications

Item	Operating Conditions		Min.	Typ.	Max.	Unit
Input Current (full load/no load)	5VDC Input	3.3VDC Output	--	735/40	758/85	mA
		Other Output	--	805/40	846/85	
	12VDC Input	3.3VDC Output	--	278/30	286/40	
		Other Output	--	314/30	338/40	
	24VDC Input	3.3VDC Output	--	140/20	145/40	
		Other Output	--	154/20	163/40	
	48VDC Input	3.3VDC Output	--	69/5	72/15	
		Other Output	--	78/5	85/15	
Reflected Ripple Current	5VDC Input		--	20	--	VDC
	12VDC Input		--	20	--	
	24VDC Input		--	55	--	
	48VDC Input		--	55	--	
Impulse Voltage	5VDC Input		-0.7	--	12	VDC
	12VDC Input		-0.7	--	25	
	24VDC Input		-0.7	--	50	
	48VDC Input		-0.7	--	100	
Starting Voltage	5VDC Input		--	--	4.5	VDC
	12VDC Input		--	--	9	
	24VDC Input		--	--	18	
	48VDC Input		--	--	36	
Input Filter			Capacitance Filter			
Hot Plug			Unavailable			
CTRL	Module off		0-0.7V turn off			
	Module on		No connect or 3.5-12V on			

Output Specifications

Item	Operating Conditions		Min.	Typ.	Max.	Unit
Output Voltage Accuracy	5% - 100% Load, Input voltage range		--	±1.0	±3.0	%
No-load Output Voltage Accuracy	Input Voltage Range	3VDC	--	±5.0	±8.0	
		Other	--	±1.5	±5.0	
Linear Regulation	Full load, Input voltage from low limit to high limit		--	±0.2	±0.5	
Load Regulation	5% - 100% Load		--	±0.6	±1.0	
Transient Recovery Time			--	0.5	3	ms
Transient Response Deviation	25% load step change		--	±2.5	±5	%

Temperature Coefficient	Full Load	--	±0.02	±0.03	%/°C
Over Current Protection		110	140	--	%Io
Short-circuit Protection		Continuous, Self-Recovery			

General Specifications

Item	Operating Conditions	Min.	Typ.	Max.	Unit
Insulation Voltage	Input-output, test time 1 minute, leakage current less than 1mA	1500	--	--	VDC
Insulation Resistance	Input-output, insulated voltage 500VDC	1000	--	--	MΩ
Isolation Capacitance	Input-output, 100KHz/0.1V	--	120	--	pF
Operating Temperature	Derating when operating temperature ≥ 85°C, (See Figure 1)	-40	--	85	°C
Storage Temperature		-55	--	105	
Storage Humidity	Non-condensing	--	--	95	%RH
Pin welding can withstand the highest temperature	Soldering spot is 1.5mm away from case for 10 seconds	--	--	300	°C
Switching Frequency	Full Load, Nominal Input Voltage	--	250	--	kHz
MTBF	MIL-HDBK-217F@25°C	>1000Kh			

Mechanical Specifications

Case Material	Black plastic; flame-retardant and heat-resistant (UL 94V-0 rated)
Package Dimensions	22.00 * 12.00 * 9.50 mm
Weight	3.8g(Typ.)
Cooling Method	Free air convection

EMC Specifications

EMI	CE	CISPR32/EN55032 CLASS B (The recommended circuit is shown in Figure 3-②)	
	RE	CISPR32/EN55032 CLASS B (The recommended circuit is shown in Figure 3-②)	
EMS	ESD	IEC/EN61000-4-2 Contact±4KV	perf.Criteria B
	RS	IEC/EN61000-4-3 10V/m	Perf.Criteria A
	EFT	IEC/EN61000-4-4 ±2KV(The recommended circuit is shown in Figure 3-①)	Perf.Criteria B
	Surge	IEC/EN61000-4-5 line to line±2KV	Perf.Criteria B
	Cs	IEC/EN61000-4-6 3 Vr.m.s	Perf.Criteria A

Typical Characteristic Curves

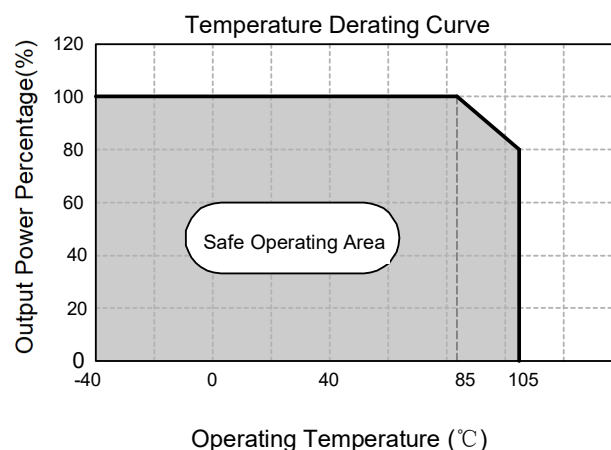
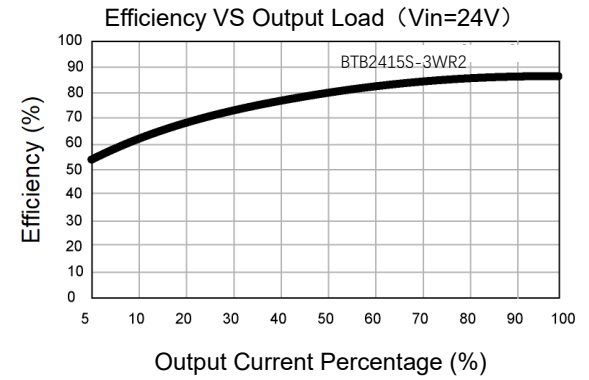
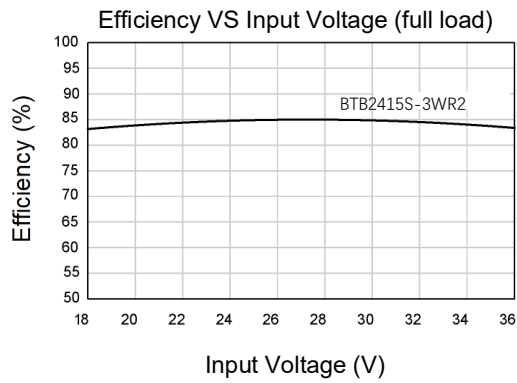
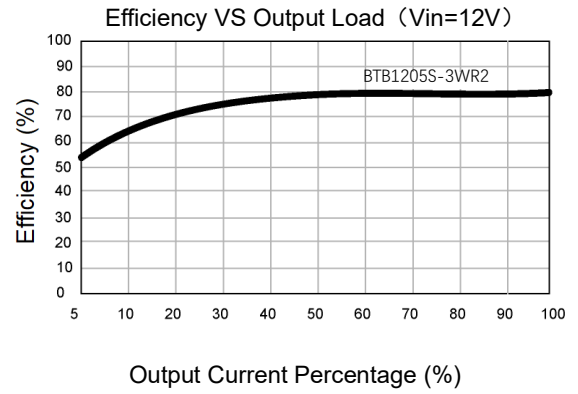
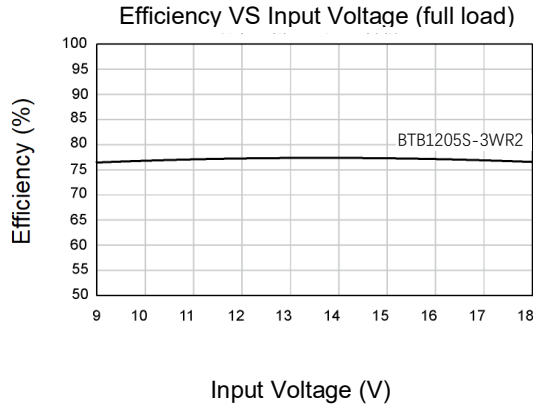

Figure 1



Circuit Design and Application

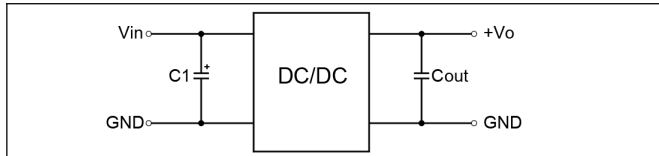

Figure 2

Recommended Capacitive Load Value Table

Cin(μF)	Cout(μF)
100	22

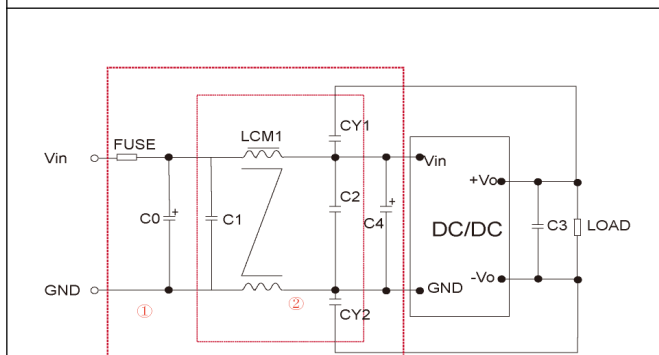

Figure 3

EMI Recommended Parameter Table

Model	Vin:12V	Vin:24V
FUSE	Select according to the actual input current of the customer	
C0, C4	330uF/35V	330uF/50V
C1, C2	10μF/50V	
LCM1	1.4-1.7mH	
C3	22μF/50V	
CY1, CY2	1nF/400VAC	

Note: Part 1 in Figure 3 is for EMC testing; The second part is used for EMI filtering, which can be selected according to the demand.

Dimensions and Recommended Layout

Dimensions

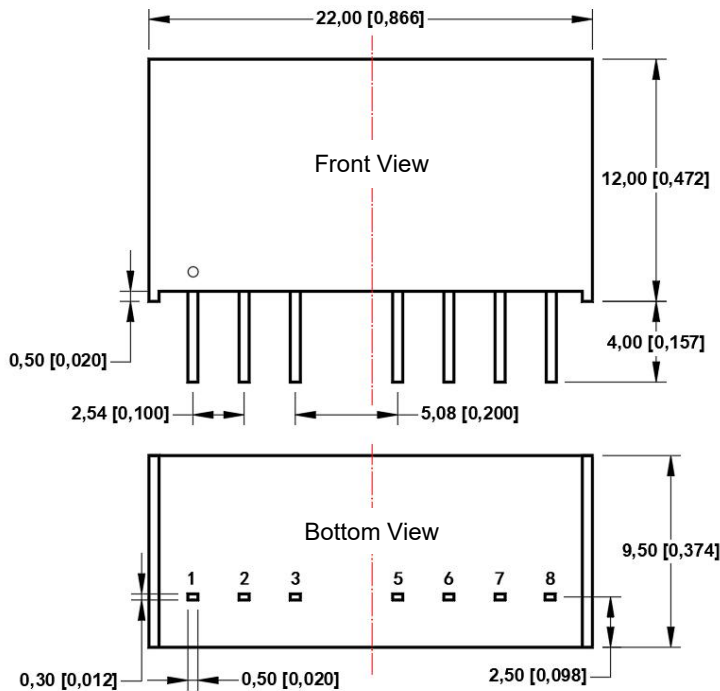

PCB Printing Layout & Pin Definition Table

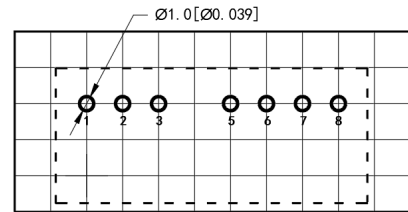

Note: The grid distance is

Pin	Function (single)	Function (double)
1	GND	GND
2	V _{in}	V _{in}
3	CTRL	CTRL
5	NC	NC
6	+V _o	+V _o
7	-V _o	COM
8	NC	-V _o

NC: Pin to be isolated from circuitry

Note:

Unit: mm[inch]

Pin section tolerances: ±0.10 [±0.004]

General tolerances: ±0.50 [±0.020]

Note:

1. If the product works under the minimum required load, it cannot guarantee that the performance of the product complies with all the performance indicators in this manual;
2. The maximum capacitive load is tested under the input voltage range and full load condition;
3. Unless otherwise stated, all indexes in this manual are measured at Ta=25°C, humidity <75%RH, nominal input voltage and rated output load;
4. All index testing methods in this manual are based on the enterprise standards of the company;
5. Our company can provide product customization, specific needs can directly contact our technical staff.