

## Product Feature

1. Package Type: 2"X 1"
2. Input voltage range: 4:1
3. Operating temperature range: -40°C - +105°C
4. Isolation voltage: 1500VDC
5. High efficiency up: 90% (Typ.)
6. Equipped with output short-circuit protection, over current protection, and over voltage protection mechanisms.
7. Fields of application: Industry, Power, Instrumentation, Communication, Rail transit.

**3 years  
Warranty**

## Selection Guide

Part No.	Input Voltage (VDC)		Output		Full Load Efficiency% (Typ.)	Capacitive Load(μF) Max.
	Nominal (Range)	Max.	Voltage (VDC)	Current (mA)		
ATB2403LD-30WR3	24 (9-36)	40	3.3	6000/0	85	10000
ATB2405LD-30WR3	24 (9-36)	40	5	6000/0	88	10000
ATB2409LD-30WR3	24 (9-36)	40	9	3333/0	88	4700
ATB2412LD-30WR3	24 (9-36)	40	12	2500/0	88	2700
ATB2415LD-30WR3	24 (9-36)	40	15	2000/0	90	1680
ATB2424LD-30WR3	24 (9-36)	40	24	1250/0	90	680
ATA2405LD-30WR3	24 (9-36)	40	±5	±3000/0	86	#2000
ATA2412LD-30WR3	24 (9-36)	40	±12	±1250/0	89	#1250
ATA2415LD-30WR3	24 (9-36)	40	±15	±1000/0	89	#680
ATA2424LD-30WR3	24 (9-36)	40	±24	±625/0	89	#470
ATB4803LD-30WR3	48 (18-75)	80	3.3	6000/0	86	10000
ATB4805LD-30WR3	48 (18-75)	80	5	6000/0	87	10000
ATB4812LD-30WR3	48 (18-75)	80	12	2500/0	88	2700
ATB4815LD-30WR3	48 (18-75)	80	15	2000/0	89	1680
ATB4824LD-30WR3	48 (18-75)	80	24	1250/0	87	680
ATA4805LD-30WR3	48 (18-75)	80	±5	±3000/0	86	#2000
ATA4812LD-30WR3	48 (18-75)	80	±12	±1250/0	90	#1250
ATA4815LD-30WR3	48 (18-75)	80	±15	±1000/0	90	#680

## Input Specifications

Item	Operating Conditions		Min.	Typ.	Max.	Unit
Input Current (full load/no-load)	24VDCnominal input series	3.3VDC Output	--	970/60	993/100	mA
		5VDC Output	--	1454/60	1488/100	
		Other Output	--	1388/6	1488/16	
	48VDCnominal input series	3.3VDC Output	--	474/20	485/30	
		5VDC Output	--	710/20	726/35	
		Other Output	--	702/5	744/10	
Reflected Ripple Current	Rated input voltage		--	40	--	mA
Impulse Voltage	24VDC nominal input series		-0.7	--	50	VDC
	48VDC nominal input series		-0.7	--	100	
Starting Voltage	24VDC nominal input series		--	--	9	
	48VDC nominal input series		--	--	18	
Input undervoltage protection	24VDC nominal input series		5.5	6.5	--	
	48VDC nominal input series		12.0	15.5	--	
Start time	Nominal input and constant resistance load		--	10	--	ms
Ctrl	turn off module		connected GND or (0-1.2V)			
	turn on module		No connected or (3.5-12V)			
	Input current when off		--	5	8	mA
Input Filter	PI filter					

## Output Specifications

Item	Operating Conditions	Min.	Typ.	Max.	Unit
Output Voltage Accuracy	5%-100% load	--	±1.0	±3.0	%
Linear Regulation	Vin=Min. to Max. @Full Load	--	±0.2	±0.5	
Load Regulation	5%-100% load	--	±0.5	±1.0	
Ripple & Noise	20MHz bandwidth,5%-100% load	--	50	100	mVp-p
Transient Recovery Time	25% Load Step Change, nominal input voltage	--	300	500	µs
Transient Response Deviation		--	±5	±8	%
Temperature Coefficient	Full Load	--	±0.01	±0.02	%/°C
Trim	input voltage range	--	±10.0	--	%
Over Voltage Protection	input voltage range	110	--	160	%
Over Current Protection	input voltage range	110	--	190	%
Short-Circuit Protection	input voltage range	Continuous, Self-Recovery			

## General Specifications

Item	Operating Conditions	Min.	Typ.	Max.	Unit
Isolation Voltage	Input-output, test time 1 minute, leakage current less than 1mA	1500	--	--	VDC
Insulation Resistance	Input-output, insulated voltage 500VDC	1000	--	--	MΩ
Isolation Capacitance	Input-output, 100KHz/0.1V	--	2000	--	pF
Operating Temperature	See Fig 1、 Fig 2	-40	--	+105	°C
Storage Temperature		-55	--	+125	°C
Storage Humidity	Non-condensing	--	--	95	%RH
Soldering Profile	1.5mm from case for 10 sec	--	--	300	°C
Switching Frequency	PWM	--	330	--	kHz
MTBF	MIL-HDBK-217F@25°C	1000	--	--	K Hours

## Mechanical Specifications

<b>Case Material</b>	Aluminum alloy
<b>Package Dimensions</b>	50.80 x 25.40 x 11.80mm
<b>Weight</b>	30.00g(Typ.)
<b>Cooling Method</b>	Free air convection

## EMC Specifications

<b>EMI</b>	CE	EN55032/CISPR32			CLASS A		
	RE	EN55032, FCC part 15			CLASS A		
<b>EMS</b>	ESD	EN61000-4-2	Air ± 8kV, Contact ± 6kV		perf.	Criteria	B
	RS	EN61000-4-3	10V/m		perf.	Criteria	A
	EFT	EN61000-4-4	±2kV		perf.	Criteria	B
	Surge	EN61000-4-5	±1kV		perf.	Criteria	B
	CS	EN61000-4-6	10Vrms		perf.	Criteria	A

**Typical Characteristic Curves**

Temperature Derating Curve (24V)

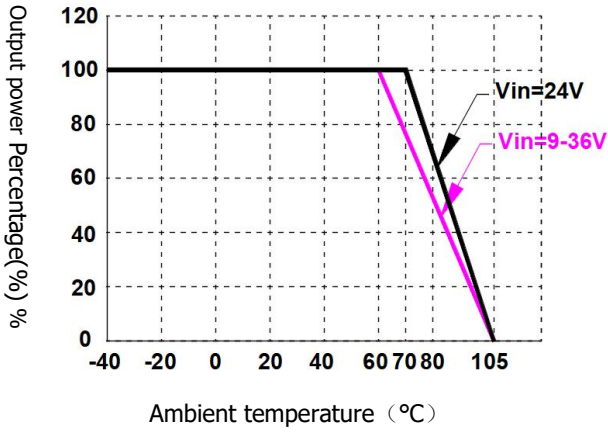

Temperature Derating Curve(48V)

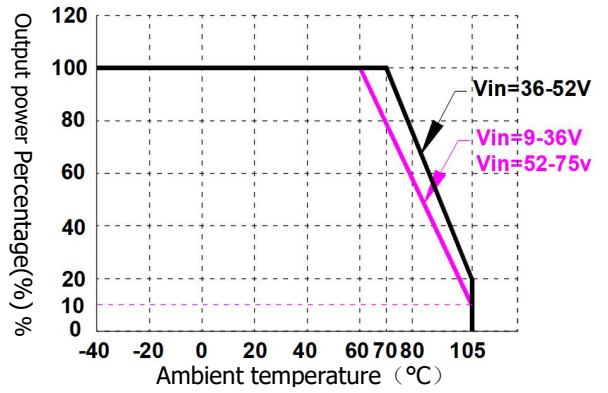

Efficiency Vs Input Voltage (Full Load)

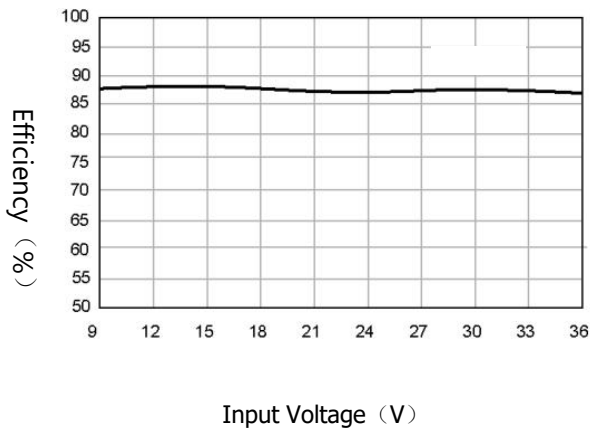

Efficiency Vs Output Load (Vin=24V)

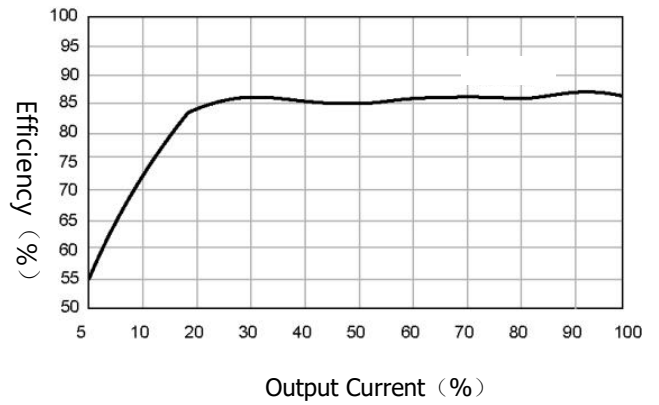

### Typical Circuit Design And Application

Figure 3		Recommended component parameters				
		Vo(VDC)	Cin(uF)	Cout(uF)		
		3.3/5/12/15	100	220		
		24	100	100		
Figure 4		EMI Recommended component parameters				
		Vin(VDC)	24VDC	48VDC		
		FUSE	Choose according to actual input current			
		MOV	20D470K	14D101K		
		C0, C1	680μF/50V	330μF/100V		
		C2	4.7μF/50V	2.2μF/100V		
		C3	Refer to the Cout in Fig.3			
		LCM	1.0mH/4A	1.0mH/2A		
		CY1/CY2	1nF/2KV			
Figure 5		Trim Recommended component parameters				
<p>Trim up</p> <p>Trim down</p> <p>Trim resistor connections (dashed line shows internal resistor network)</p>		Vout(V)	R1(KΩ)	R2(KΩ)	R3(KΩ)	Vref(V)
		3.3	10	6.064	13.622	1.24
		5	2.4	2.344	13.622	2.5
		12	8.2	2.153	17.346	2.5
		15	12	2.388	21.016	2.5
		24	10	1.158	10.714	2.5

All DC-DC converters of this series are tested before delivery using the recommended circuit shown in Fig. 3. Input and/or output ripple can be further reduced by appropriately increasing the input & output capacitor values  $C_{in}$  and  $C_{out}$  and/or by selecting capacitors with a low ESR (equivalent series resistance). Also make sure that the capacitance is not exceeding the specified max. capacitive load value of the product.

**Dimensions and Recommended Layout**

**Dimensions**

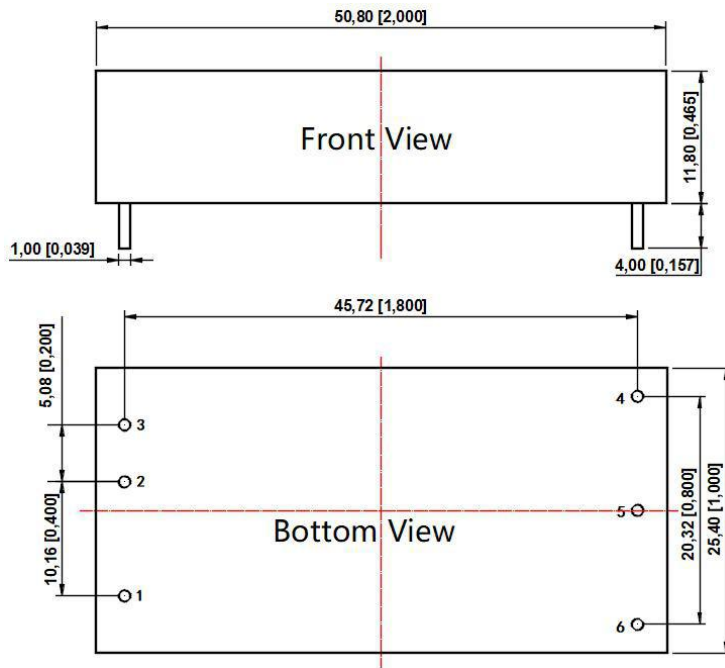

Note:

Unit: mm[inch]

Pin section tolerances: ±0.10 [±0.004]

General tolerances: ±0.50 [±0.020]

**PCB Printing Layout**

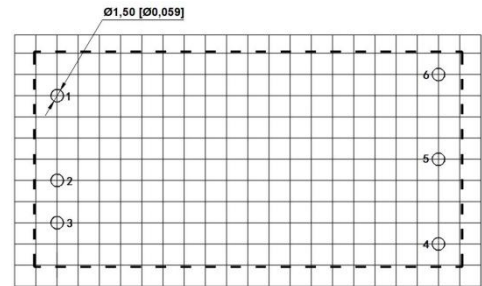

The grid distance is 2.54 x 2.54mm

**Pin Definition Table**

Pin	Function (Single)	Function (Dual)
1	Ctrl	Ctrl
2	GND	GND
3	Vin	Vin
4	+Vo	+Vo
5	-Vo	COM
6	Trim	-Vo

**ATA(B)\_LD-30WR3A4S Dimensional drawing**

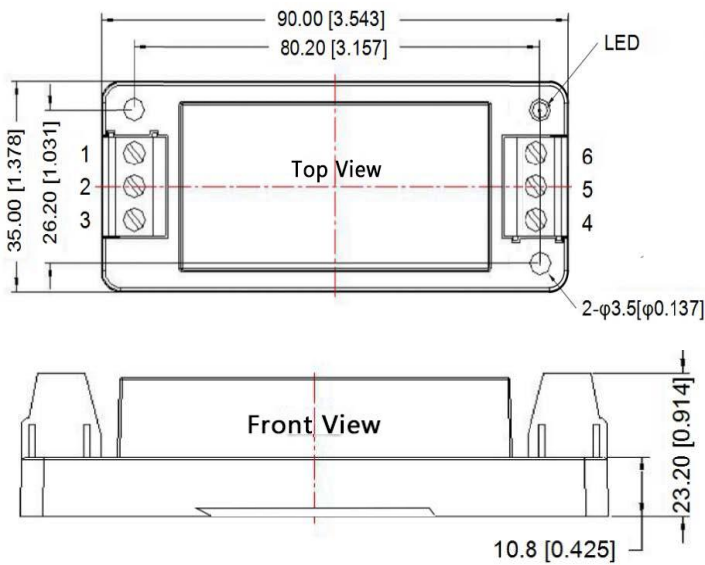

**Pin configuration**

Pin	1	2	3	4	5	6
Single	Ctrl	GND	Vin	+Vo	0V	Trim
Dual	Ctrl	GND	Vin	+Vo	0V	-Vo

**Note:**

1. The input voltage should not exceed the specified range value, otherwise it may cause permanent and irreparable damage;
2. It is recommended to use at a load of over 5%. If the load is below 5%, the ripple index of the product may exceed the specifications, but it does not affect the reliability of the product;
3. Suggested dual output module load imbalance:  $\leq \pm 5\%$ . If it exceeds  $\pm 5\%$ , it cannot be guaranteed that the product performance meets all performance indicators in this manual;
4. The maximum capacitive load is tested within the input voltage range and under full load conditions;
5. Unless otherwise specified, all indicators in this manual are measured at  $T_a=25\text{ }^\circ\text{C}$ , humidity $<75\%$  RH, nominal input voltage, and output rated load;
6. All indicator testing methods in this manual are based on our company's corporate standards;
7. Our company can provide product customization, and specific requirements can be directly contacted by our technical personnel;
8. Product specifications are subject to change without prior notice.